

**Article Info**

Received: 25 Jan 2016 | Revised Submission: 20 Feb 2016 | Accepted: 28 Feb 2016 | Available Online: 15 Jun 2016

**GSM Based Electronics –Notice Board**

*Prerana Chauhan\**, *Shikhar Agarwal\*\**, *Hem Kumar Singh\*\*\** and *Ashish Saini\*\*\*\**

**ABSTRACT**

*In this technical paper explains how a reliable and an authentic wireless communication could be easily developed between a mobile phone and microcontroller using GSM (Global System for Mobile Communication) MODEM (Modulator-Demodulator). This technical paper explains GSM based e-notice board which can be widely used for multitude of applications including educational sector, traffic control, banks, public advertisements, stock exchanges etc. Moreover we can also learn as well as modify some of the common applications of GSM MODEM as per the requirements and needs of the user. Here we will learn the hardware behind the picture. In addition to this I will tell you how to upgrade the software resulting low NRE (Non-Recurring Engineering) cost as well as low time-to-market. This technical paper plays a vital role in the state-of-the-art scenario where market window is relentlessly shrinking and really need pocket-friendly and authentic products.*

**Keywords:** *Transformer; Diode(IN4007); GSM; Voltage Regulator 7805; Microcontroller; LED; Transistor; MAX 232; IC 74154; IC 74138.*

**1.0 Introduction**

In this project it is possible to display as SMS on moving led pattern. For this project we use GSM modem as a main component. We send the SMS via mobile phone to particular GSM modem. Data from the modem is connected to the microcontroller VIA SERIAL PORT. Data is get into the microcontroller and store in the memory and then after into the microcontroller.

This project is to be divided into two parts. One is GSM modem connectivity and second is moving display board. The main aim of this project will be to design a SMS driven automatic display board which can replace the currently used programmable electronic display. It is proposed to design receiver cum display board which can be programmed from an authorized mobile phone.

The message to be displayed is sent through a SMS from an authorized transmitter. The microcontroller receives the SMS, validates the sending Mobile Identification Number (MIN) and

displays the desired information. The GSM modem receives the SMS. The AT commands are serially transferred to the modem through Rx-Tx connection. The microcontroller validates the SMS and then displays the message in the LED display board

**2.0 Main Function of GSM Based E-Notice Board**

Sending message from any of the remote area to the distant located e-notice board using GSM mobile.

For sending the text message from remote area we need to interface the mobile phone with GSM Modem. For developing some of GSM based applications we need to have some commons peripherals including GSM MODEM, SIM, microcontroller, LED, power supply and also some connecting wires.

Moreover GSM based applications could be easily developed and enhanced due to easily accessibility of components in local markets at very pocket friendly prices.

*\*Corresponding Author: Department of Electronic Engineering, Moradabad Institute of Technology, Moradabad, (UP) India (E-mail: Chauhanprerana.mit@gmail.com; Ashishsaini49@gmail.com)*

*\*\*Department of Electronic Engineering, Moradabad Institute of Technology, Moradabad, (UP) India*

*\*\*\*Department of Electronic Engineering, Moradabad Institute of Technology, Moradabad, (UP) India*

*\*\*\*\* Department of Electronic Engineering, Moradabad Institute of Technology, Moradabad, (UP) India*

**2.1 Block diagram of GSM-based E-notice board**

Here you can see the simple block diagram of GSM- based e-Notice board. Essential components for assembling GSM based applications including:

1. GSM MODEM
2. Microcontroller
3. SIM
4. Power Supply or Power Adapter
5. Transformer
6. Bridge Rectifier
7. LED

Let’s start discussion one by one.

**Fig 1: Block Diagram of GSM Based E- Notice Board**

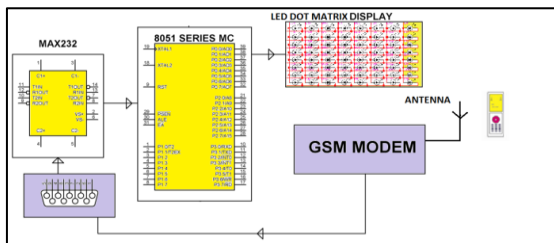

**2.2GSM Modem:** A GSM modem is a wireless modem that works with a GSM wireless network. It operates at either the 900MHz or 1800MHz frequency band. It supports voice calls and data transfer speeds of up to 9.6kbits/s, together with the transmission of SMS (Short Message Service). The GSM Modem comes with a serial interface which the modem can be controlled using AT command interface.

**Fig 2: GSM Modem**

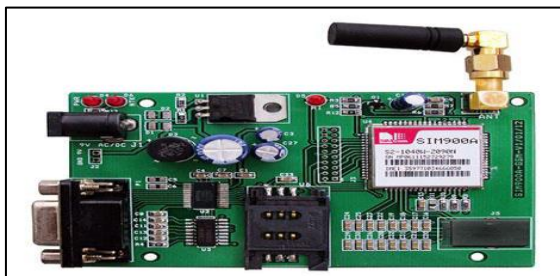

**2.3 SIM:** Subscriber Identity Module is a clip-on small card consisting of user’s information as well as phone book. As per convenient, user can alter the operator with retaining the same handset. Nowadays dual SIM handset is also available in the local market

which brings the advantage of two different operators at the same time.

**Fig 3: SIM Card**



**2.4 Power Supply:** In this project firstly we use one step down transformer from 220 volt Ac to 12 volt Ac. This AC voltage is further converted into DC with the help of rectifier circuit. In rectifier circuit we use two-diode.

Output of the rectifier is now regulated with the help of IC regulator circuit. We use 7805 regulator then its means it 5 volt regulator and if we use 7808 regulator then its means that it is 8 volt regulator circuit. In this project we use 5 volt dc regulated power supply for the complete circuit. Separate 9 volt dc power supply is used for the relay coil.

**Fig 4: +5V DC Power Supply**

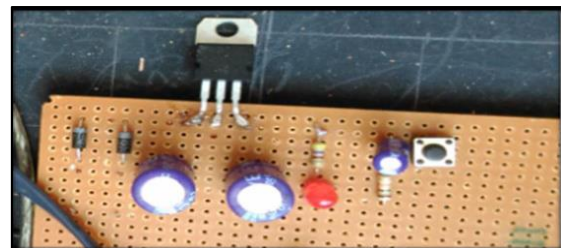

**2.5Transformer:** Transformer is a static electrical device which transfers electrical energy from one circuit to another circuit. Depending upon winding, transformer could be easily understand with primary winding and secondary winding.

**Fig 5: Step Down Transformer**



**Fig 6: 8051 Microcontroller**

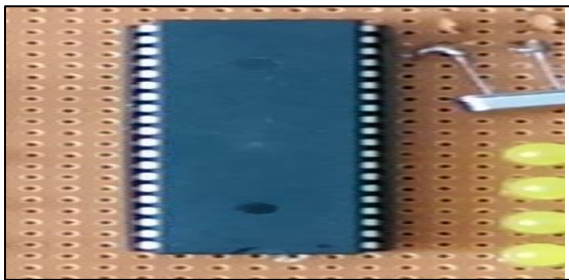

**2.5 Microcontroller:** Microcontroller is a small computer on a single integrated circuit containing a processor core, memory and programmable I/O peripherals.

- The 8051 microcontroller has Harvard architecture with RISC (Reduced Instruction Set Computer) concept.
- 8051 has 8-bit ALU which can perform all the 8-bit arithmetic and logical operations in one machine cycle. The ALU is associated with two registers A & B special function registers.
- Microcontroller - specially designed for performing single task, is a computer-on-a-chip usually comprises of I/O ports, RAM, ROM and also CPU.

**2.6MAX 232:** MAX 232 that converts signals from an RS-232 serial port to signals suitable for use in TTL compatible digital logic circuits. The MAX 232 is a dual driver/receiver and typically converts the RX, TX CTS and RTS signals vice versa for converting from RS232 to TTL. . It changes a TTL Logic 0 to between +3 and +15V, and changes TTL logic 1 to between -3 to -15V, and

**Fig 7: MAX 232**



**2.7 IC 24c02:** It is a non-volatile memory and is used for the storage of message in case any new SMS is not received by the modem. It used as memory reservoir to store previous message.

- Pins in 24C02-
- 1-SDA (Serial Data)

- 2-SCL (Serial Clock)
- 3-WP (Write Protect)
- 4-Device/Page Address pins (AO,A1,A2)
- 5-Ground (GND)
- 6-VCC

**Fig 8: IC 24c02**

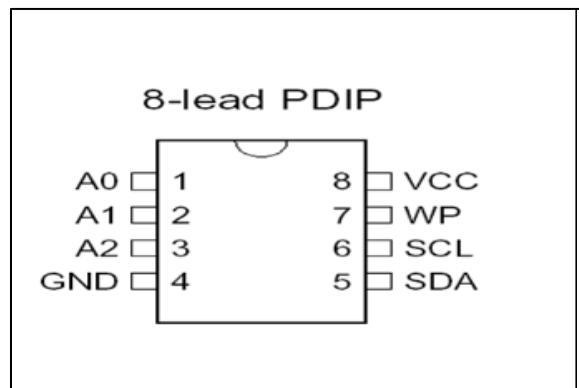

**2.8 LED Dot Matrix Display:** A led dot-matrix display is a display device used to display information on machines, clocks, railway departure indicators and many other devices requiring a simple display device of limited resolution. The display consists of a dot matrix of lights or mechanical indicators arranged in a rectangular configuration (other shapes are also possible, although not common) such that by switching on or off selected lights, text or graphics can be displayed. A dot matrix controller converts instructions from a processor into signals which turns on or off lights in the matrix so that the required display is produced.

**Fig 9: LED Dot Matrix Display**



**2.9. Flowchart of E-notice board**

In section III we discuss the operational flowchart of GSM based e-notice board.

**3.0 Some Important Initializing Steps for GSM Based E-Notice Board:**

In the section IV we will learn some simple steps for the initialization of GSM based e-notice

board. How to access GSM MODEM using Microsoft Hyper Terminal:

- Before programming the application software we need to assure that our GSM MODEM as well as SIM is either correctly working or not.
- This status could be easily identified with the help of hyper terminal by sending AT (Attention) commands to the GSM MODEM.
- For windows users we can use “Hyper command Terminal” and for LINUX users we can use “Mincom” terminal.

**3.1 Testing of GSM modem:**

- After placing SIM card in GSM MODEM, we need to directly go to hyper terminal for further communication.
- Then type AT in main window. If a response OK is returned back to mobile phone then type AT-CMGR which is again a AT command which means read message from a given memory location.

**Fig 10: Flow Chart**

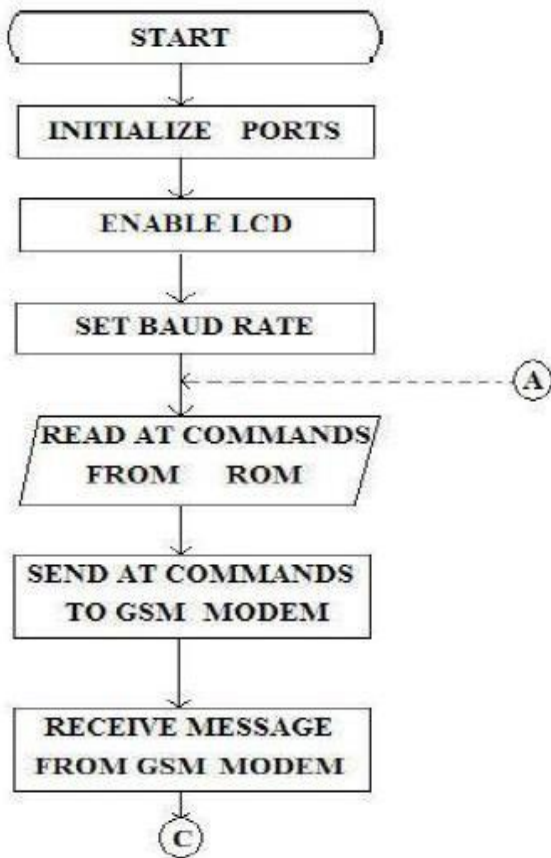

**Fig 11: KEIL Software**

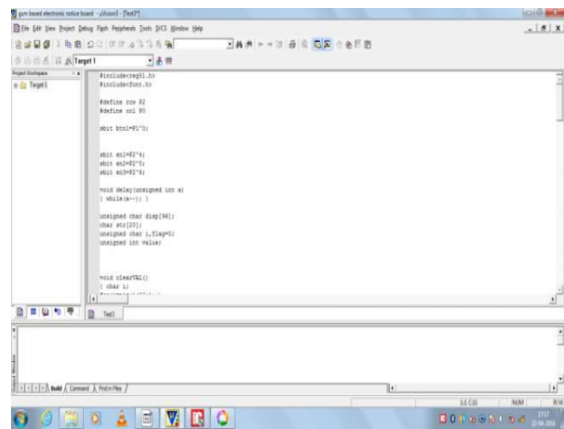

**4.0 Results**

**Initializing**

**Fig 12: Initialization**



**Typing the message in the mobile**

**Fig 13: Typing the Message in the Mobile**



**Enter the valid authenticated phone number**

**Fig 14: Enter the Valid Authenticated Phone Number**





Send the message

Fig 15: Send the Message



Message is displayed in the notice board

Fig 16: Message is Displayed in the Notice Board



Change the message

Fig 17: Change the Message



Send the new message

Fig 18: Send the New Message



New Message displayed

Fig 19: New Message Displayed



### 3.2 How to initialize the microcontroller:

- For initializing the microcontroller with MODEM we need to use mainly 2 terms named as DTE and DCE.
- DTE – Data Terminal Equipment is a piece of hardware device for communication.
- DCE – Data Communication Equipment provides the path for communication.

### 3.3 Software environment:

**3.3.1 KEIL Software for 8051 Family:** KEIL – founded in 1982, provides broad range of development tools including libraries, IDE (Integrated Development Environment), assemblers and also linkers.

**3.3.2 HEX file:** HEX file is a special file which is imported by a programmer into the target IC. Hex file is a kind of file which is actually not for user.

### 4.0 Conclusions

The prototype of the GSM based display toolkit was efficiently designed. This prototype has facilities to be integrated with a display board thus making it truly mobile. The toolkit accepts the SMS, stores it, validates it and then displays it in the LED module. The SMS is deleted from the SIM each time it is read, thus making room for the next SMS. The major constraints incorporated are the use of as the termination character of the SMS and the display of one SMS as a time.

The GSM based digital notice board system that we have created has been in practical use in various companies like in construction companies and research areas, railways, Colleges.

This technology could be further modified and more upgraded as per individual need and interest. We have discussed some basic ideas of this technology. And depending on innovative applications user can upgrade as per requirement.

### References

- [1] Janice Gillispie, Mazidi Rolin D. McKinlay, Muhammad Ali. Book: The 8051 Microcontroller and System

- [2] SiegmundRedl, Matthias Weber, Malcolm W. Oliphant. Books: GSM and Personal Communications Handbook
- [3] Pawan Kumar, VikasBhrdwaj, Kiran Pal, Narayan Singh Rathor, Amit Mishra, GSM based e-Notice Board, International Journal of Soft Computing and Engineering (IJSCE).
- [4] Agamanolis.S, Digital displays for human connect endless.In public and situated display Social and international aspects of shared display technology.
- [5] Herman Chung- HwaRao, Di-Fa Chang and Yi-Bing Lin, ISMS: An Integration Platform for Short Message Service and IP Networks, IEEE Network, 48-56, March/April (2001).
- [6] Jeff Brown, Bill Shipman and Ron Vetter, SMS: The Short Message Service, IEEE Computer Society, 106-111, 2007.
- [7] QianXu, Evan Wei Xiang, Qiang Yang, Jiachun Du, JiepingZhong, Agamanolis.S, SMS Spam Detection Using Noncontent Features, IEEE Computer Society, 44-51, 2012.